

The logo for HOPERF, featuring the word "HOPERF" in a bold, sans-serif font. The letter "H" is red, and the letters "OPERF" are black. A registered trademark symbol (®) is located at the top right of the "F".

HOPERF[®]

The text "Hope Microelectronics" is displayed in a white, bold, sans-serif font, centered within a solid red rectangular background.

Hope Microelectronics

The Leading RF IC supplier of China

Version 1.0

1

RF switch and lighting Recommendation

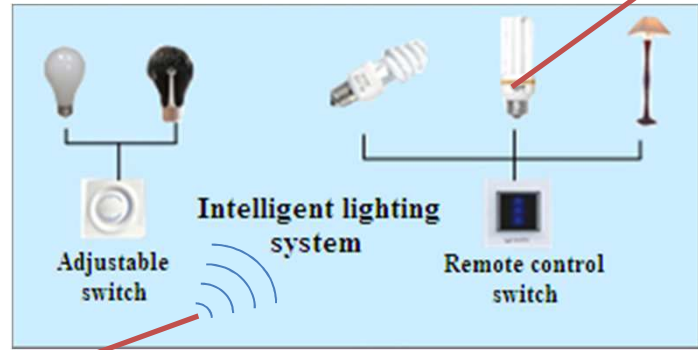

Recommended Receiver IC

ASK : CMT2210A/L, CMT2217A
CMT2250A, CMT2251A
ASK/FSK/GFSK :
CMT2213A, CMT2219A

Recommended Transmitter IC

ASK : CMT2110A, CMT2117A
CMT2150A, CMT2157A
ASK/FSK/GFSK :
CMT2113A, CMT2119A

More relevant industry applications

- Remote control switch
- Remote control socket
- Wireless Dimming lights
- small household appliances and so on

More details: [Http://www.hoperf.com](http://www.hoperf.com)

Traditional RF Solutions

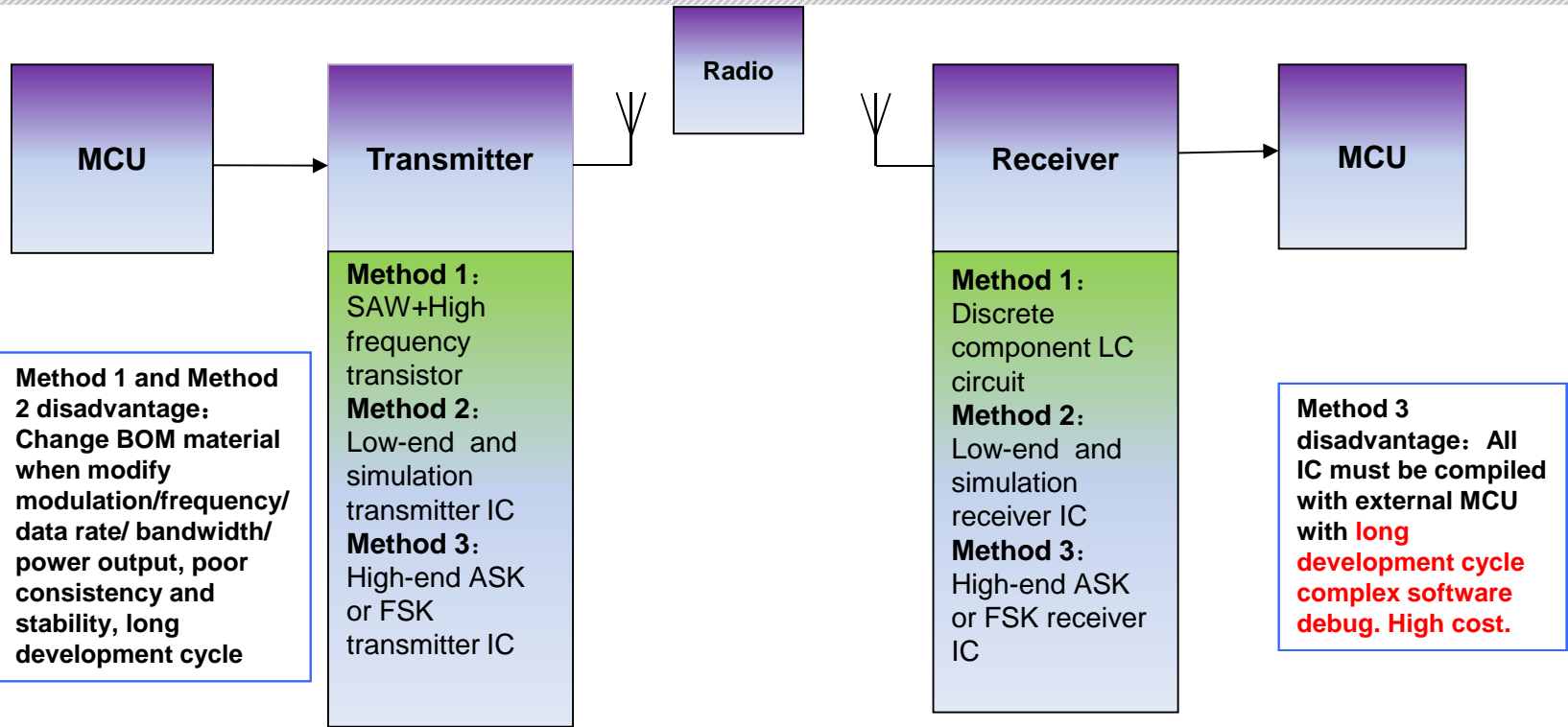

HopeRF Innovated RF Solutions

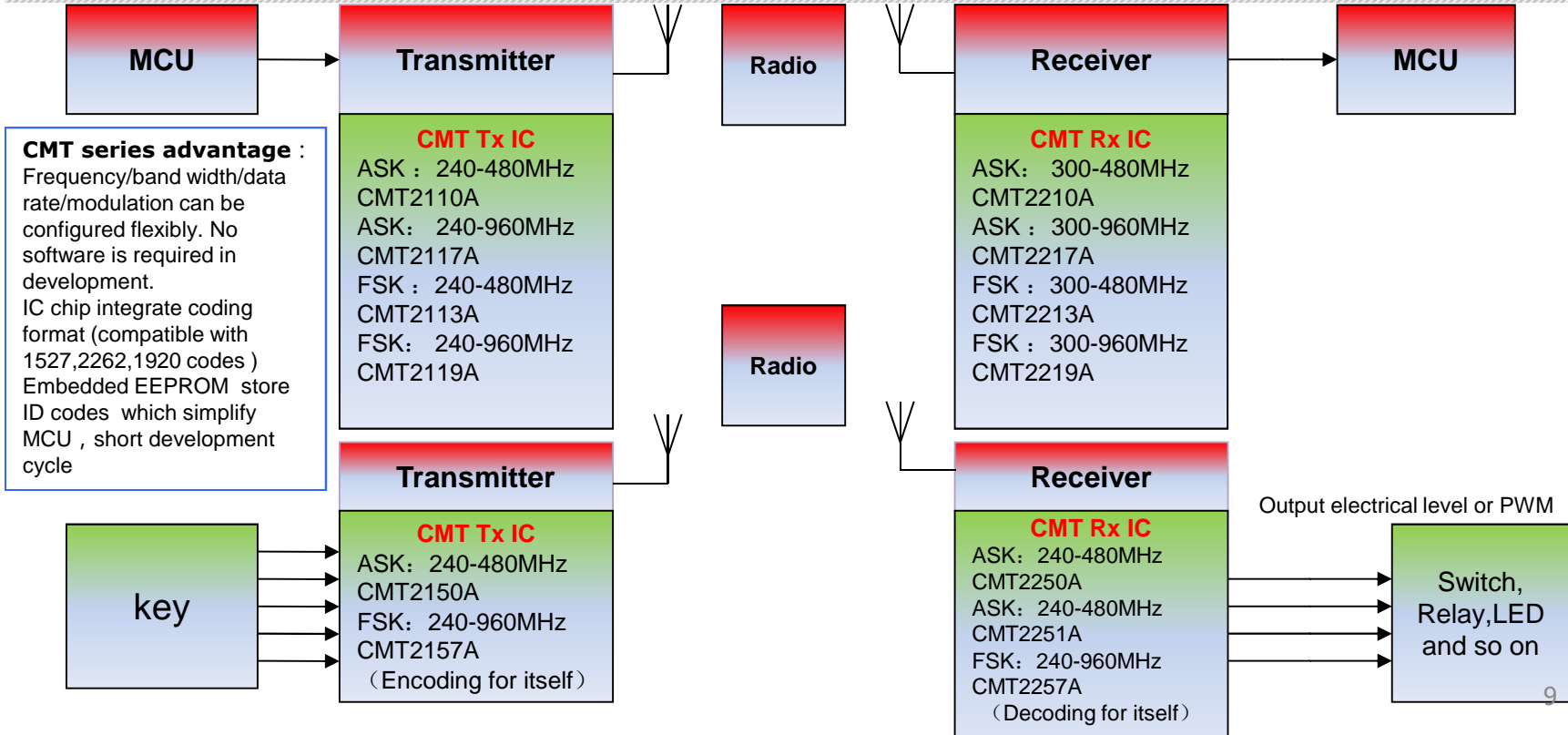

CMT series advantage :
 Frequency/band width/data rate/modulation can be configured flexibly. No software is required in development.
 IC chip integrate coding format (compatible with 1527,2262,1920 codes)
 Embedded EEPROM store ID codes which simplify MCU , short development cycle

Advantage of CMT Series

HOPERF[®]

- ◆ Frequency/output power/data rate/modulation can be configured flexibly. No software development is required, Greatly shortens the development cycle and simplifies the production.
- ◆ Unique differential antenna design, Perfect for compact size Remote Controller.
- ◆ CMT2150A integrated fixed coding (compatible with 1527/2262/1920,etc), no external MCU is required.
- ◆ CMT2250A integrated fixed decoding, no external MCU is required.
- ◆ Min bandwidth 50kHz, max. link budget up to 127dBm Long communication distance , strong anti-interference ability.
- ◆ Data input, antenna output. No need to change the software, ASK/FSK switched each other easily, easy upgrading from ASK to FSK.
- ◆ CMT series are Pin-to-Pin compatible, All ICs are work with a 26MHz crystal and support any frequency within 300MHz-960MHz. One hardware design is compatible with many CMT series ICs. Simplified BOM helps to reduce the material cost effectively.
- ◆ Embedded EEPROM (optional) , storage capacity (Tx:32bytes,Rx64bytes),Save MCU resources, support millions online repetitive programming.
- ◆ Max. output power is 13dBm,which is configurable at 1dBm step. Big Harmonic allowance and will easily pass the approvals.
- ◆ High sensitivity -114dBm, Working current 3.5mA at ASK & 4.2mA at FSK, embedded duty cycle mode to reduce power consumption. Meets the requirements of FCC & ETSI certification(blocking certification 300K)

Development example-easiest development platform

HOPERF®

Step 1 : Reserve “burn” spot at PCB Layout stage

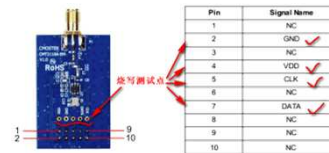

Example: CMT2110A

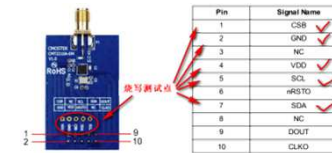

Example: CMT2210A

Step 2: Connect PC with USB programmer

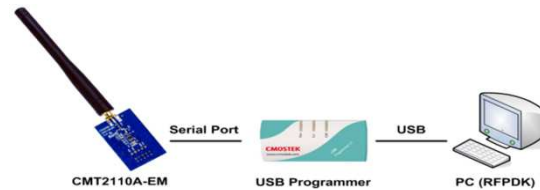

Example: CMT2110A

Step 3: Open GUI RFPDK to config RF values then click “Burn” , RF IC is configured.

RF parameters like frequency/output power / duty cycle can be configured on RFPDK

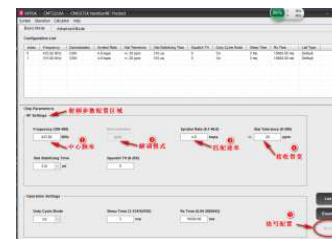

Example: CMT2210A

CMT Series Selection Table

HOPERF[®]

IC	Model	Modulation	Frequency range	Tx output power	package	Remark	Pairing IC	Corresponding module
Tx IC	CMT2110AW	OOK	240-480MHz	+13dBm	SOT23-6	TWI/Two wire interface	CMT2210AW	RFM110W
	CMT2117AW	OOK	240-960MHz	+13dBm	SOT23-6	TWI/Two wire interface	CMT2217AW	RFM117W
	CMT2119AW	(G)FSK/OOK	240-960MHz	+13dBm	SOT23-6	TWI/registers configuration	CMT2219AW	RFM119W
	CMT2150AW	OOK	240-480MHz	+13dBm	SOP14	Standalone+8 keys	CMT2250AW/ 51AW	NONE
	CMT2157AW	(G)FSK/OOK	240-960MHz	+13dBm	SOP14	Standalone+8 keys	CMT2257AW	NONE
	CMT2180AW	OOK	240-480MHz	+13dBm	SOP14	Soc+4 keys + differential PA	CMT22xxAW	NONE
	CMT2189AW	(G)FSK/OOK	240-960MHz	+13dBm	SOP14	Soc+4 keys + differential PA	CMT22xxAW	NONE

CMT Series Selection Table

IC	Model	Modulation	Frequency range	Sensitivity	Package	Remark	Pairing Tx IC	Corresponding module
Rx IC	CMT2210AW	OOK	300-480MHz	-114dBm	QFN16(3*3)	Standalone+1 DATA output	CMT2110AW	RFM210W
	CMT2217AW	OOK	400-960MHz	-116dBm	QFN16(3*3)	Standalone+1 DATA output	CMT2117AW	RFM217W
	CMT2219AW	(G)FSK/OOK	300-960MHz	-116dBm	QFN16(3*3)	4 wire spi+1(DATA) output	CMT2119AW	RFM219W
	CMT2250AW	OOK	300-480MHz	-114dBm	QFN16(3*3) /SOP16/DIP 16	Standalone+4 DATA output	CMT2150AW	NONE
	CMT2251AW	OOK	300-480MHz	-114dBm	QFN16(3*3)	Standalone+1 DATA output(PWM)	CMT2150AW	NONE
TRX IC	CMT2300AW	(G)FSK/OOK	300-960MHz	-120dBm/ +20dBm	QFN16(3*3)	4 wire spi	CMT2300AW	RFM300W

The End

HOPERF[®]

Hope Microelectronics Co.,Ltd

The leading manufacturer of IoT sensors and RF products

THANKS!

Your distributor:
www.ideetron.nl/hoperf
+31 343 769 094